

MODEL 363X

Dual Noise Gate

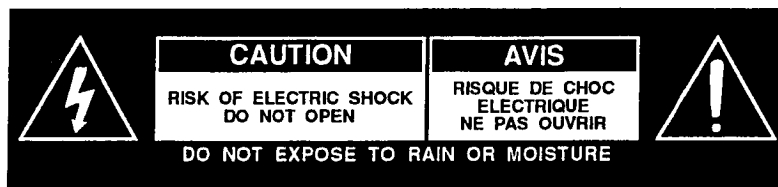

SERVICE MANUAL
(Preliminary)



CAUTION: TO REDUCE THE RISK OF ELECTRICAL SHOCK, DO NOT REMOVE COVER (OR BACK). NO USER SERVICEABLE PARTS INSIDE. REFER SERVICING TO QUALIFIED SERVICE PERSONNEL.

WARNING: TO REDUCE THE RISK OF FIRE OR ELECTRICAL SHOCK, DO NOT EXPOSE THIS APPLIANCE TO RAIN OR MOISTURE.



This symbol, wherever it appears, alerts you to the presence of uninsulated dangerous voltage inside the enclosure — voltage that may be sufficient to constitute a risk of shock.



This symbol, wherever it appears, alerts you to important operating and maintenance instructions in the accompanying literature. Read the manual.

Manufactured under one or more of the following U.S. patents: 3,377,792; 3,681,618; 3,714,462; 3,789,143; 4,097,767; 4,329,598; 4,403,199; 4,409,500; 4,425,551; 4,473,795. Other patents pending.

This dbx-branded product has been manufactured by AKG Acoustics, Inc.

AKG is a registered trademark of Akustische u. Kino-Geräte Ges m.b.H., Austria. All trademarks are property of their respective companies.

This manual is part number 96015-000-02

© Copyright 1993 by AKG Acoustics, Inc.

75 - FB - 1/93

dbx

dbx Professional Products

a division of AKG Acoustics, Inc.

1525 Alvarado Street, San Leandro, CA 94577 USA

Telephone (1) 510/351-3500 Fax: (1) 510/351-0500

Introduction

The half rack design of the 363X can accommodate up to four channels of gating in one rack space, or 16 channels of gating in four rack spaces.

The 363X can be a useful tool in any musical situation.

In the studio, the 363X can be used to:

- Eliminate headphone leakage into the microphones
- Gating drum mics to eliminate rattling snares or to tighten the sound of a kick drum
- Gating instrument mics to eliminate amp noise
- Muting the mixdown inputs to the two-track as an economical solution to automation

In live sound applications, the 363X can be used to gate:

- signal processing gear that produce hum such as synthesizers, samplers and electronic drums
- Microphones for lead vocals, background vocals, drums and other musical instruments
- Microphones that are intermittently used
- Noisy digital and analog reverb and delay devices

Special Applications

The 363X gating action can be controlled by an external signal at the Key Input on the rear panel. This is useful for applications such as frequency weighted gating or anticipatory gating for zero attack times.

Front Panel

dbx 363X

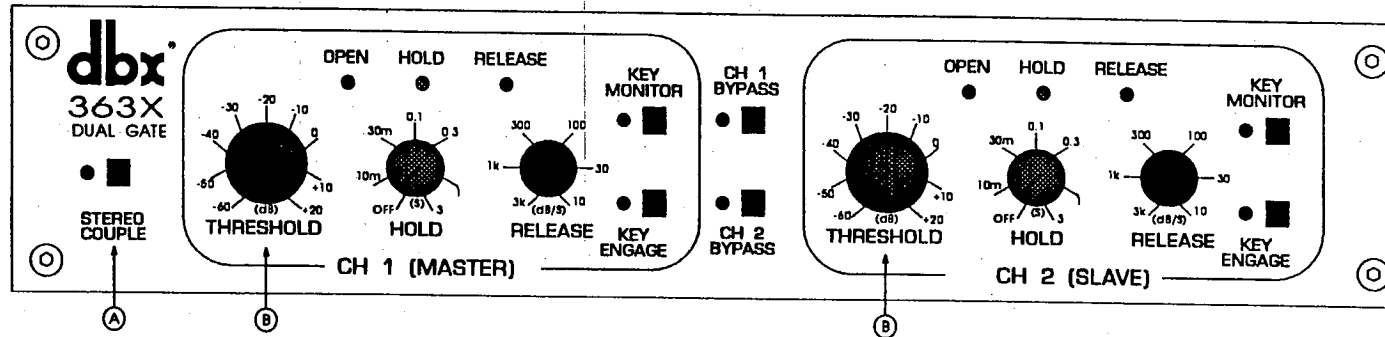

Figure 1: Front Panel

A. STEREO COUPLE switch and LED.
Depress this switch to activate Stereo-coupling (CH 1 MASTER, CH 2 SLAVE). The LED next to the STEREO COUPLE button turns on when the 363X is actively stereo coupled. In Stereo Couple mode, the THRESHOLD, HOLD and RELEASE controls on Channel 2 have no effect on the gating action. The Channel 2 OPEN, HOLD and RELEASE LEDs track with Channel 1 meters.

B. THRESHOLD control and OPEN LED (CH 1 and CH 2)
Adjusting this control sets the level at which the gate will open with regard to the Input level. The THRESHOLD control is calibrated in dB from -60 to +20dB, to provide an 80dB operating range.

The green OPEN LED located above the THRESHOLD control turns on whenever the input signal (or Key Input signal) rises above the set THRESHOLD level.

Front Panel

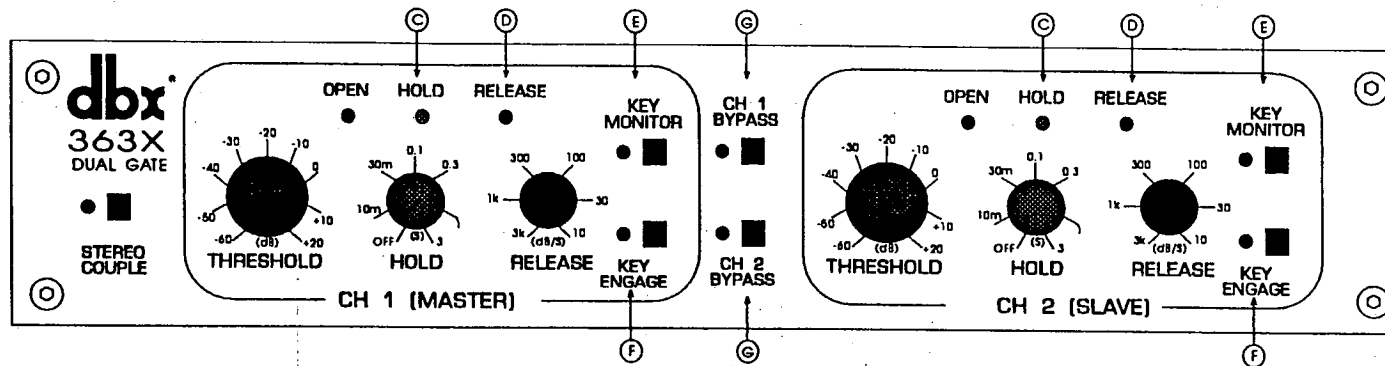

Figure 2: Front Panel

C. HOLD control and HOLD LED (CH 1 and CH 2)

The Hold function determines the amount of time the gate remains open after the input signal falls below the threshold. The HOLD control is calibrated in seconds, with a range of 0 (OFF) to 3 seconds.

When the HOLD function is used, the yellow HOLD LED turns on as soon as the input level falls below the threshold. The HOLD LED will remain illuminated until the HOLD function has completely timed out.

Front Panel

dbx 363X

D. RELEASE control and RELEASE LED (CH 1 and CH 2)

The RELEASE control determines the rate at which the gate closes once the signal at the input falls below the threshold and the HOLD function is timed out.

The RELEASE control is calibrated from 3000 dB/second to 10 dB/second.

The intensity of the red RELEASE LED will increase as the attenuation increases. If the Release rate is set for a fast release, the LED illuminates quickly.

E. KEY MONITOR switch (CH 1 and CH 2)

Depressing this switch allows the signal at the KEY input to be routed directly to the audio output. When KEY MONITOR is selected, all of the front panel functions are inactive except BYPASS.

F. KEY ENGAGE switch (CH 1 and CH 2)

Depressing this switch causes the channel to respond to the signal at the KEY input. When the Key Engage switch is depressed and no signal is present, the 363X does not pass any signal.

G. BYPASS switch (CH 1 and CH 2)

Depressing the BYPASS button creates a "hard-wire bypass" of the 363X circuitry by connecting the input directly to the output.

BYPASS overrides all controls, even if power is removed from the 363X.

Rear Panel

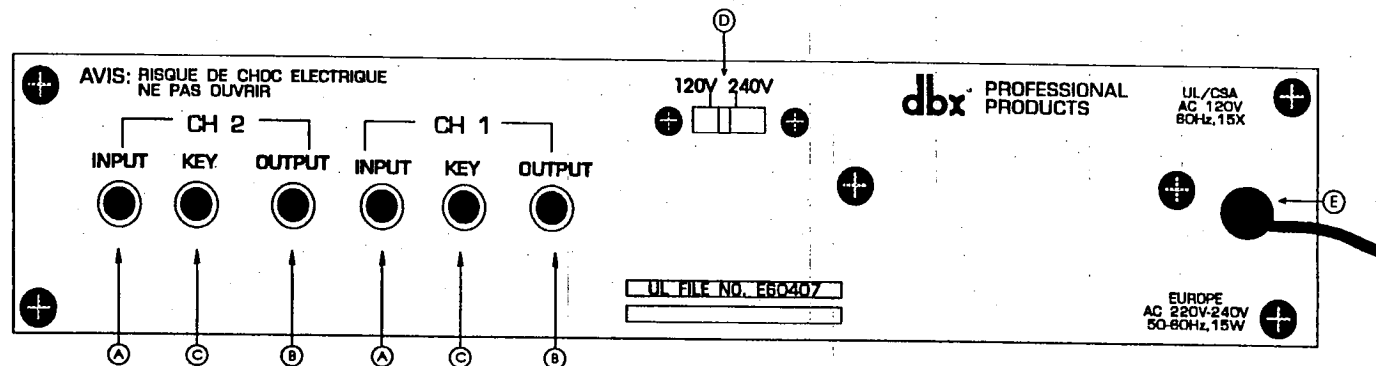

Figure 3: Rear Panel

- A. **INPUT Connector (CH 1 and CH 2)**
The signal input of the 363X is unbalanced and can accept a maximum input level of +18dBu. It requires a 1/4" Tip/Sleeve phone plug.
- B. **OUTPUT Connector (CH 1 and CH 2)**
The signal output of the 363X is unbalanced and is capable of driving +18dBu into a 600Ω load. It requires a 1/4" Tip/Sleeve phone plug.
- C. **KEY Input (CH 1 and CH 2)**
The KEY input is unbalanced and can accept a maximum input level of +20dBu. It requires a 1/4" Tip/Sleeve phone plug.

- D. **AC Voltage Select Switch**
Selects for use between 120VAC or 240VAC operation. Be sure to determine the line voltage before applying power to the 363X.

Rear Panel

dbx 363X

E. AC power cable

Connect this cable to any 50Hz or 60Hz AC power source of the correct line voltage, as shown by the AC LINE VOLTAGE requirement indicator above. Note that the 363X does not have a power switch. It is recommended that the 363X be "ON" at all times. The Model 363X consumes a maximum of 12 watts AC power.



WARNING: Be sure to verify both your actual line voltage and the voltage for which your Model 363X was wired, as indicated on the rear panel of your unit. Connection to an inappropriate power source may result in extensive damage which is not covered by the warranty.

Connecting The 363X To Your System

System Connections

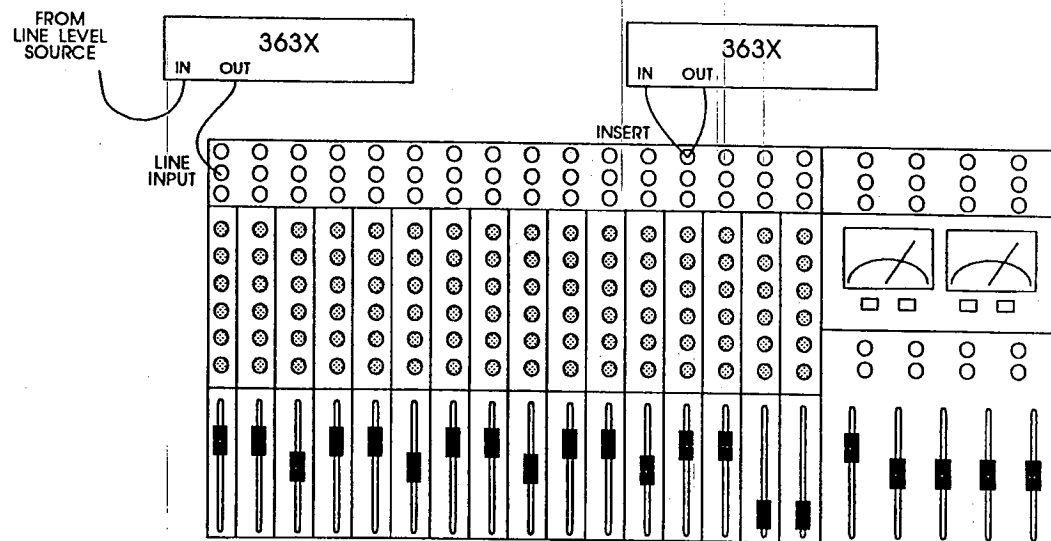

Figure 4: Connecting a 363X to a Mixing Board

The 363X can be used with any line-level device. Some common examples include: mixing consoles, musical instruments, patch bays, and signal processors.

A. Mixing Board:

If you wish to gate a particular track of a multi-track recording or one channel of a live performance mix, the 363X output can be directly connected to a line input jack, or wired to an Insert point.

Connecting The 363X To Your System

dbx 363X

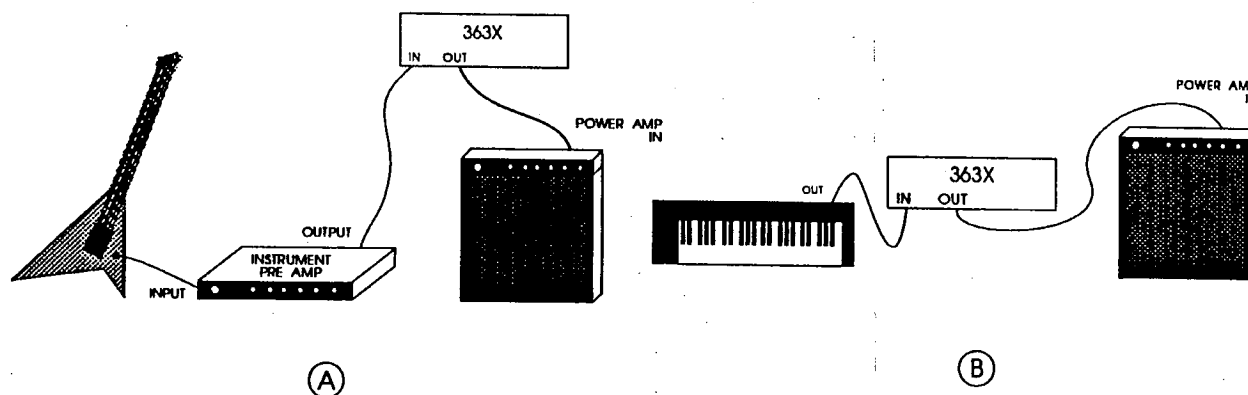

Figure 5: Connecting a 363X to a Guitar

B. Musical Instruments (i.e., Electric Guitar, Bass, Keyboards):

Because the 363X has an 80dB input range, the output of an electric guitar can drive the 363X's input. For greater sensitivity and improved signal to noise, it is recommended that the 363X be connected to the "PREAMP OUT" of your guitar amp (if so equipped), or the output of some other device that is designed to accept low-level instrument inputs (including various stomp boxes, rack mount audio products, and the dbx Performer Series processing units). Fig-

ure 5A shows the 363X connected between the output of a pre-amp and the input of a power amp.

Microphones, like guitars, also typically have low-level outputs. Therefore, it is recommended that the 363X be connected after the mic pre-amp.

In Figure 5B, the 363X is connected to the outputs of a synthesizer to gate out the constant noise inherent in most keyboards.

Connecting The 363X To Your System

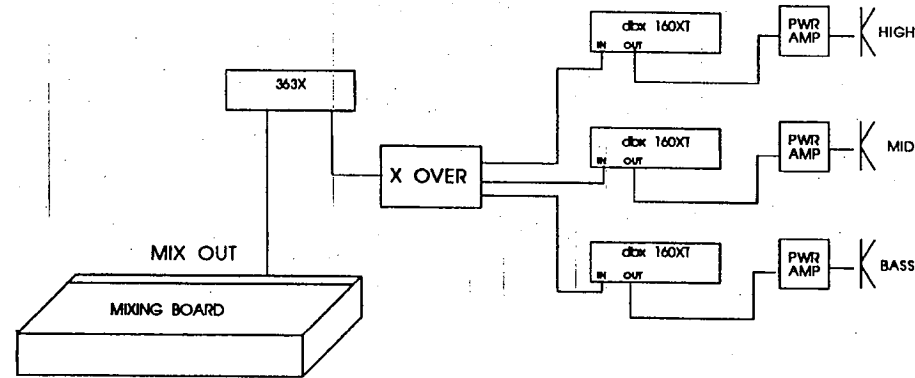

Figure 6: Connecting the 363X for Sound Reinforcement

C. Sound reinforcement:

Placing the 363X in series with the main mix output is a cost effective means of eliminating hum and buzz from the house speakers. Simply set the threshold level low enough to allow the gate to open at the presence of a signal, but high enough to gate out the noise.

Connecting The 363X To Your System

dbx 363X

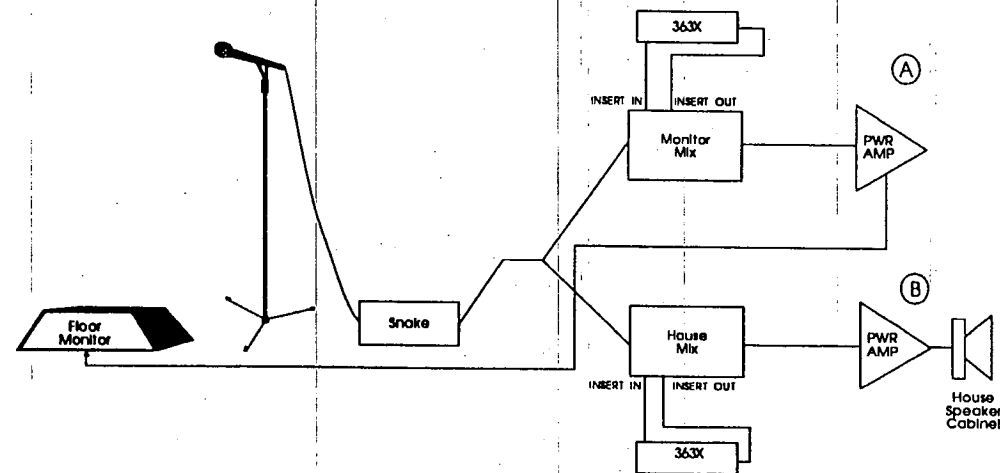

Figure 7: Connecting the 363X for Live Applications

The 363X can be used in a variety of ways in live sound reinforcement. In Figure 7A, the 363X is being used to gate the vocal mike on and off in the floor monitors. This is an excellent means of suppressing feedback into the monitors when the microphone is not being used. Normally feedback is not a problem into the house speakers, however there are in-

stances when these cabinets are placed on the stage just in front of the band. The 363X can provide controlled isolation when mics located close to these speakers are open. Figure 7B shows the typical connection.

Connecting The 363X To Your System

Studio Applications

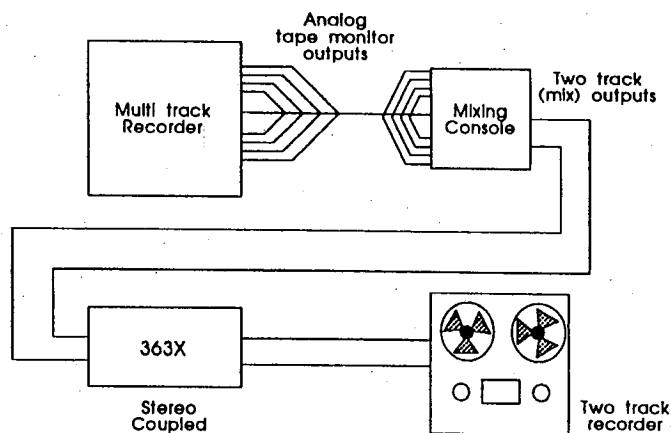

Figure 8: Multi Channel Connections

The 363X can be set for 2-channel stereo operation by pressing the STEREO COUPLE button. This will force Channel 2 (SLAVE) to track Channel 1 (MASTER) to preserve proper stereo imaging.

Channel 1 controls will adjust the amount and nature of the gating and Channel 2 will track accurately.

In Figure 8 the 363X is switched to the stereo couple mode and inserted into the signal path

between the mix outputs of the console and the inputs of the 2-track mixdown machine. The threshold of the 363X is set low enough to gate out the hiss from the multi-track but open at the presence of a signal. This is an effective means of achieving automation muting with consoles not equipped with this feature.

The 363Xs two channels operate completely independently when the STEREO COUPLE button is not depressed.

Special Connections (OPTIONAL)

dbx 363X

Using The Key Input

To control the 363X gate by signals other than the audio input (via an auxiliary device), connect the auxiliary device's output to the 363X's KEY Input jack, and feed the auxiliary device's input with the same signal fed to the 363X's Signal Input. In Figure 9, an equalizer input is connected in parallel with the signal input of the 363X. The equalizer is adjusted to accentuate the frequencies that will control the gating action. The output of the equalizer is then fed to the Key Input of the 363X. When the microphone receives audio the 363X will open and pass the signal through to the output of the 363X at unity gain. Using the 363X in this configuration will eliminate false triggering from other nearby sound sources.

NOTE: You could substitute a guitar or other instrument for the snare.

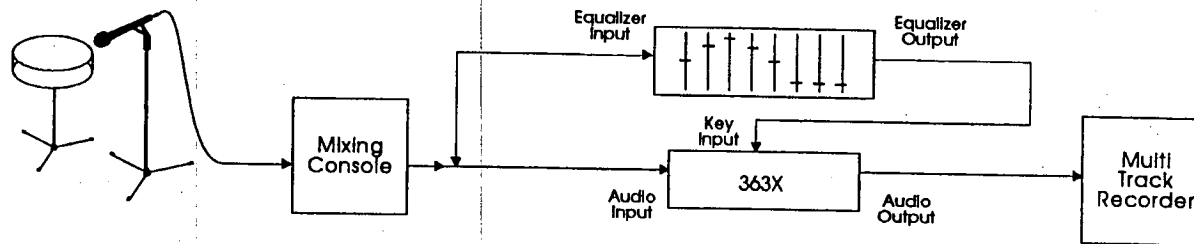

Figure 9: Using the 363X Key Input

Basic Operation (Control Descriptions)

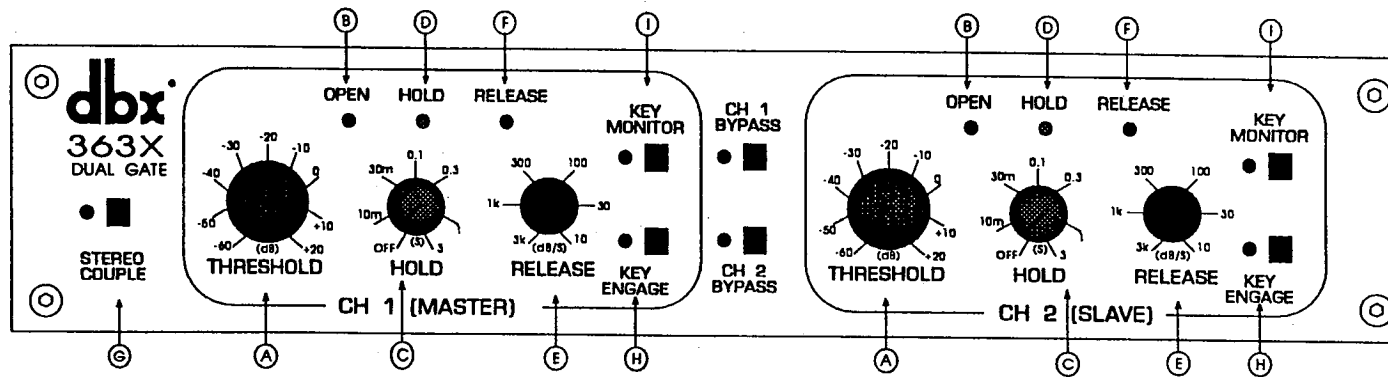

Figure 10: Front Panel

Basic Operation (Control Descriptions)

dbx 363X

A. THRESHOLD control:

The Threshold control sets the level at which the gate will open and allow the signal at the input to pass through to the output. The 363X has an 80dB threshold range which will allow it to be used with a variety of low level and line devices. Turn the THRESHOLD control completely clockwise. Set the HOLD control to the OFF position and set the RELEASE control around 1000dB/S. Apply the signal to be gated to the input of the 363X and adjust the THRESHOLD control counter-clockwise until the signal can be heard at the output. The THRESHOLD control should be set so the gate opens every time the signal is applied. If the dynamics of the instrument being gated changes dramatically in the context of the performance, it may be necessary to re-adjust the THRESHOLD to allow the softer signals to open the gate.

B. OPEN LED

The green LED labelled "OPEN" illuminates when the signal has crossed over the set threshold level and quickly extinguishes when the signal falls under the threshold. This LED can also serve as a signal present indicator when trouble-shooting through your system.

C. HOLD control

The Hold control is used to reduce false triggering and to allow for a certain amount of decay time inherent to some types of musical instruments. The hold circuit begins its timing process once the signal falls under the threshold. The 363X provides up to a maximum of 3 seconds of hold time. An example of when the hold function would be utilized would be to allow a piano or guitar to fade naturally without truncating the signal. Or another use would be to capture the reverb as it is trailing off after the initial snare drum hit. In order to capture the entire envelope naturally, it will be necessary to use the Release function in conjunction with the Hold function. However, using a long hold time with a short release time can create some interesting special effects.

D. Hold LED

When the Hold function is used, the yellow LED labelled "HOLD" illuminates when the signal falls below the threshold and remains illuminated until the hold circuitry has completely timed out.

Basic Operation (Control Descriptions)

E. RELEASE

The Release control determines how quickly the gate will close after the signal falls under the threshold of after the hold function has timed out. The Release time range is adjustable from 3000dB/s to 10dB/S. This provides a release characteristic that ranges from a sudden cut-off to a gradual fade. The 363X has a fixed attenuation level of 90dB and the graduated scale on the front panel gives these attenuation times.

Front Panel Settings:	Time to full attenuation:
3kdB/S	30ms
1kdB/S	90ms
300dB/S	330ms
100dB/S	900ms
30dB/S	3 Sec
10dB/S	9 Sec

F. RELEASE LED

The red LED labelled "RELEASE" illuminates with growing intensity as the attenuation level increases. This serves as a dynamic indication of the attenuation's rate status.

G. STEREO COUPLE control

The STEREO COUPLE switch internally straps channel one and two together when it is depressed. Once the 363X is switched to the STEREO COUPLE mode, channel one becomes the master and channel two becomes the slave. The front panel controls for channel one adjust both the master and the slave units to insure proper tracking of the VCAs. The channel two controls have no effect on the signal when the 363X is in the stereo couple mode.

Basic Operation (Control Descriptions)

dbx 363X

H. KEY ENGAGE switch

The KEY ENGAGE switch, when depressed, allows the opening and closing of the gate to be controlled by an external signal. This becomes an invaluable feature when many sound sources exist in a close proximity. For instance, a conventional drum kit consists of five pieces, not including the cymbals. In order to get a good overall drum sound, each drum needs a mic on it. This gives the engineer the ability to "doctor" each drum individually. The one single-most issue engineers complain about is leakage into adjacent mics. A noise gate can, in most cases, eliminate the crosstalk into nearby mics by simply gating them off allowing only the drum that is struck to trigger the gate. In order to keep the isolation between the drums, the threshold level must be set to the point at which only that particular drum will trigger the gate. However, if the threshold level is set too high, the natural dynamics of the drum can be lost. Inserting an equalizer into the KEY input on the 363X will enable the gate to respond to signals specifically tailored for each drum. For example, if the snare drum hit causes the gate used for the hi-hat to open the gate, a parallel feed from the hi-hat into an equalizer and then into the KEY input of the 363X will allow only the hi-hat hit to open the gate. This is achieved by emphasizing the frequencies in the hi-hat range so the gate only responds to the selected frequencies and bandwidth. When no

signal connection is made to KEY input connector and the KEY ENGAGE switch is depressed, the 363X will not function. See page 13 for the proper connections.

I. KEY MONITOR switch

The KEY MONITOR switch, when selected, allows the signal at the KEY input connector to be monitored at the output connector. This provides a quick method of "dialing in" the signal that will ultimately trigger the gate.

Specific Applications

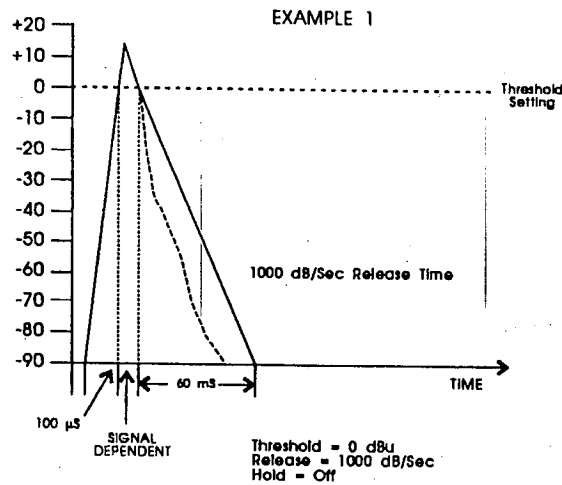

Figure 11: Operation with Snare Drum or Kick Drum

The 363X provides no amplification when a signal is passed through it. Therefore the 363X does not need any calibration or alignment before it is placed into operation. Basic signal connections are covered in the previous section titled "Connecting the 363X to Your System." This section will address each of the controls and indicators on the dbx 363X. In order to successfully operate the 363X it should be understood that the THRESHOLD,

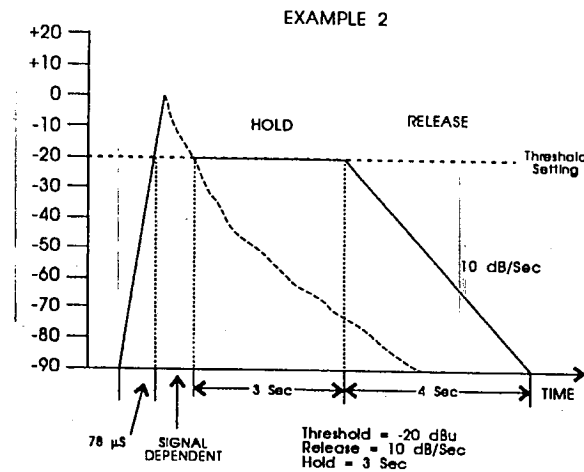

Figure 12: Operation with Cymbal or Piano

HOLD and RELEASE functions, although separate controls, work together to allow the gate to be used effectively in a wide variety of applications. As with most signal processing units, experimenting is usually the best method to gain an understanding. Below are a couple of examples of how the 363X can be used.

Specific Applications

dbx 363X

Example 1: With the THRESHOLD setting around +10dB, and the HOLD control set to the OFF position, and the RELEASE control set around 1000dB/S, the input to the 363X is less sensitive to nearby signals that would cause the gate to open or to "chatter." Once a signal falls under the threshold, the fast release setting will enable the gate to close very quickly. This would be a suitable setup for use with a snare drum or kick drum where the initial transient gets through, and due to the quick delay time of these types of instruments, the gate closes almost immediately (see Figure 11). This is actually an effect that is used quite often in the studio to tighten-up a drum track. These particular settings would not work for a crash cymbal or a piano which are instruments that inherently have a certain amount of sustain and decay past the initial transient.

Example 2: With a THRESHOLD setting around -20dB, and the HOLD control set around 3 seconds, and the RELEASE control set around 10dB/S, the 363X will allow lower signals to open the gate, while the long hold and release settings will allow the gate to remain open to capture the entire envelope of the signal. These would be good settings for the piano or the crash cymbal mentioned in example 1 (see Figure 12). These settings would allow the instrument to decay naturally before the gate would close and truncate the signal.

These are just a couple of examples of how the 363X can be adjusted to keep out the noise while still maintaining the integrity of the signal being gated. The 363X also can be gated ON and OFF by a completely different signal source or by taking a parallel feed from the same signal that is connected to the audio input and passing it through an equalizer or digital delay line and then plugging it into the Key input on the 363X. This would allow the 363X to respond only to signals that have been tailored to open and close the gate. These are what we consider to be Special Connections. On page 13 we outline a couple of special connections that are the most frequently used.

Installation Considerations

Power Considerations

Connect Power.

- A. Check the line voltage.

The 363X is shipped for 115 or 230V, 50 or 60Hz operation. Refer to the unit's rear panel to verify your unit's precise line voltage.

- B. Connect the 363X's power cord to an appropriate AC power source.

Mounting the 363X in a Rack (OPTIONAL)

Mount the 363X in a 1U rack space (1.75 inches, 4.45 cm).

A 363X requires one rack space (height) and 1/2 rack space (width). It can be mounted above or below anything that doesn't generate excessive heat, since it requires no special ventilation. Ambient temperatures should not exceed 113°F (45°C) when equipment is powered. Mounting ears and a blank half-panel for a single unit are provided. Two 363X units may be mounted side-by-side in one rack space.

In addition, all dbx "half-rack" units share a common chassis and mounting scheme. As a result, any dbx Performer Series signal processor (163X Compressor, 263X De-Esser, 463X Over-Easy Noise Gate, or 563X Hiss Reducer) may be mounted next to the 363X to save rack space. The dbx 150X Type I Noise Reduction unit may also be mounted next to the 363X. Hardware for side-by-side mounting is included with each half-rack product. If the rubber feet were used for table top operation, they should be removed at this time.

Caution: Never remove the cover. There are no user-serviceable parts inside, and you run the risk of a fatal electric shock.

Installation Considerations

dbx 363X

To install a single 363X (left or right side)

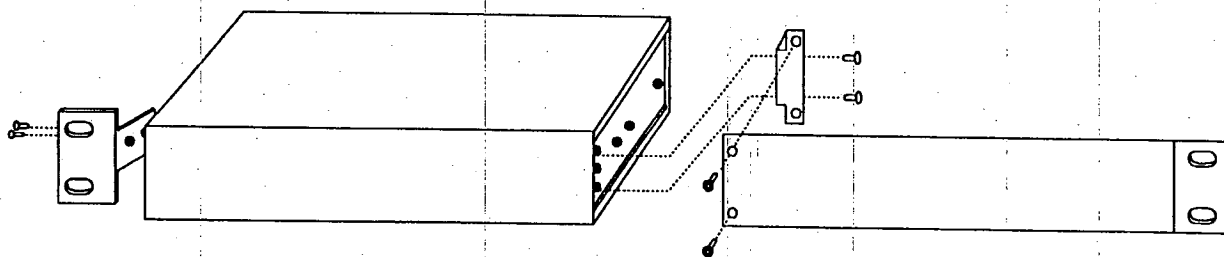

Figure 14: Installing One 363X Unit

You will need:

1	blank black panel
1	rack ear
1	blank panel adaptor piece
1	3/32" Allen wrench
1	Phillips screwdriver (not included)
4	pan head Phillips screws
2	hex head screws

NOTE: Your 363X assembly kit includes the tools and hardware listed above, except as noted.

- A. Use a Phillips screwdriver to loosely attach the single rack ear to either side of the 363X with two pan head Phillips screws.

NOTE: If this is the first time the rack ear has been installed, you will be cutting threads as you drive the screws. This is normal.

- B. Loosely attach the adaptor piece to the other side of the 363X using two more pan head Phillips screws and a Phillips screwdriver. See note above.
- C. Loosely attach the blank panel and adaptor piece using an Allen wrench and two hex head screws.
- D. Align everything on a flat surface and tighten the screws with a Phillips screwdriver and the hex wrench.

Installation Considerations

To install two units side-by-side

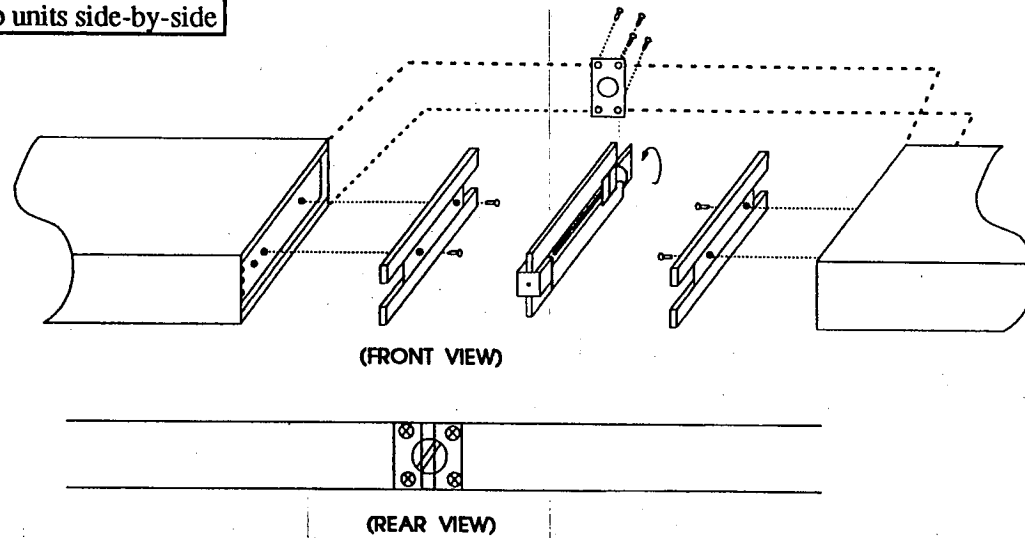

Figure 15: Installing Two 363X Units

You will need:

1	joiner assembly (joiner, joiner side pieces)
1	reinforcing plate
2	rack ears
1	3/32" Allen wrench
1	Phillips screwdriver (not included)
4	pan head Phillips screws
4	flat head countersink screws

NOTE: Your 363X assembly kit includes the tools and hardware listed above, except as noted.

Installation Considerations

dbx 363X

- A. Remove the joiner assembly from the assembly kit that was supplied with each unit. Note how the joiner side pieces are held captive by the joiner before you separate them. This is important when it comes time to join the units together. Now separate the joiner side pieces from the joiner by turning the thumbscrew counterclockwise.
- B. At this time you will need to designate a "Left" and a "Right" unit.
- C. With the left unit facing you, loosely attach a rack ear to the left side of the unit with two pan head Phillips screws. On the right side of the unit, place a joiner side piece into the extruded channel so the holes in the unit align with the holes in the joiner side piece — countersink side up. Secure the joiner side piece with two countersink screws.

NOTE: If this is the first time the rack ear has been installed, you will be cutting threads as you drive the screws. This is normal.
- D. Repeat Step "C" with the "Right" unit; swapping right for left with regard to the rack ear mounting and left for right with regard to the joiner side piece mounting.
- E. Place the Left and Right units on a flat surface, rear facing, so the joiner side pieces are approximately 2" apart. Take the joiner as-

sembly and loosen the thumbscrew so the sliding catches clear the joiner side-piece cut-outs. Now place the joiner assembly against one of the units with the side piece so it lays flush. (The joiner assembly should be positioned so the thumbscrew is accessible from the rear of the unit.) While holding the joiner assembly in position, slide the other unit over so it mates flush with the joiner assembly and turn the thumbscrew clockwise until it is snug. Do not over-tighten. Both units should now be secured together.

- F. Make sure everything is aligned, and tighten the screws on each of the two rack ears.

NOTE: For installations where the two units will be subjected to physical stress (e.g. portable operations), a small **OPTIONAL** reinforcement plate is included. See steps 1-G through 1-I. If you don't wish to use the reinforcing plate, skip the following steps.

- G. Turn the two units so that the back faces you. Remove the four rear cover screws nearest the joiner knob.
- H. Place the reinforcing plate over the joiner knob so that the four screw holes line up.
- I. Replace the four screws, using the slightly longer screws provided in the Accessory Kit.

Installation Considerations

Input Cable Configurations

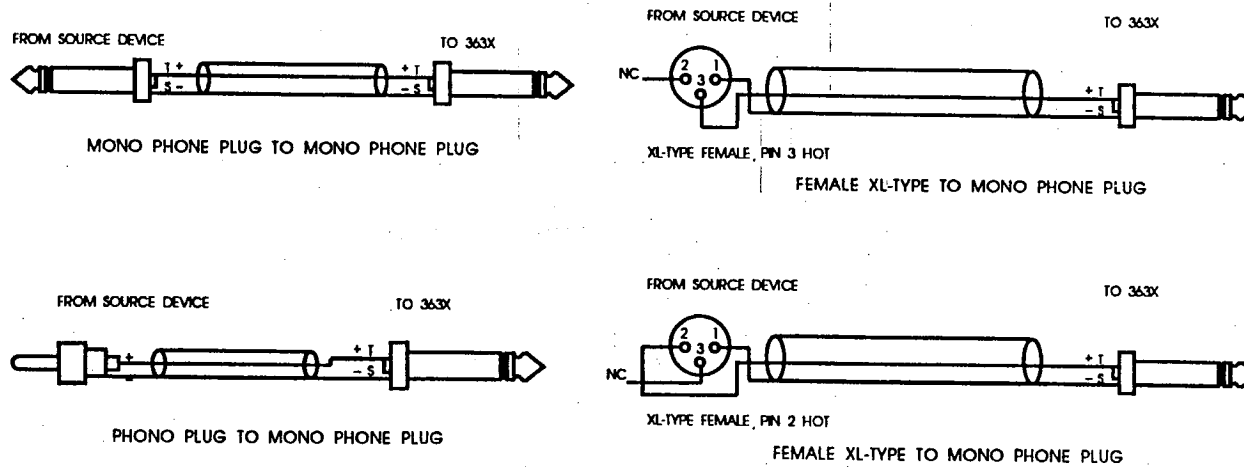

Figure 16: Input Connections

Connect Audio Inputs

The 363X has an actual input impedance of 20k Ω . This makes the 363X audio input suitable for use with virtually any source impedance, low or high.

NOTE: Wherever mono phone plugs are shown, stereo phone plugs may be substituted. Just leave the RING disconnected.

Output Cable Considerations

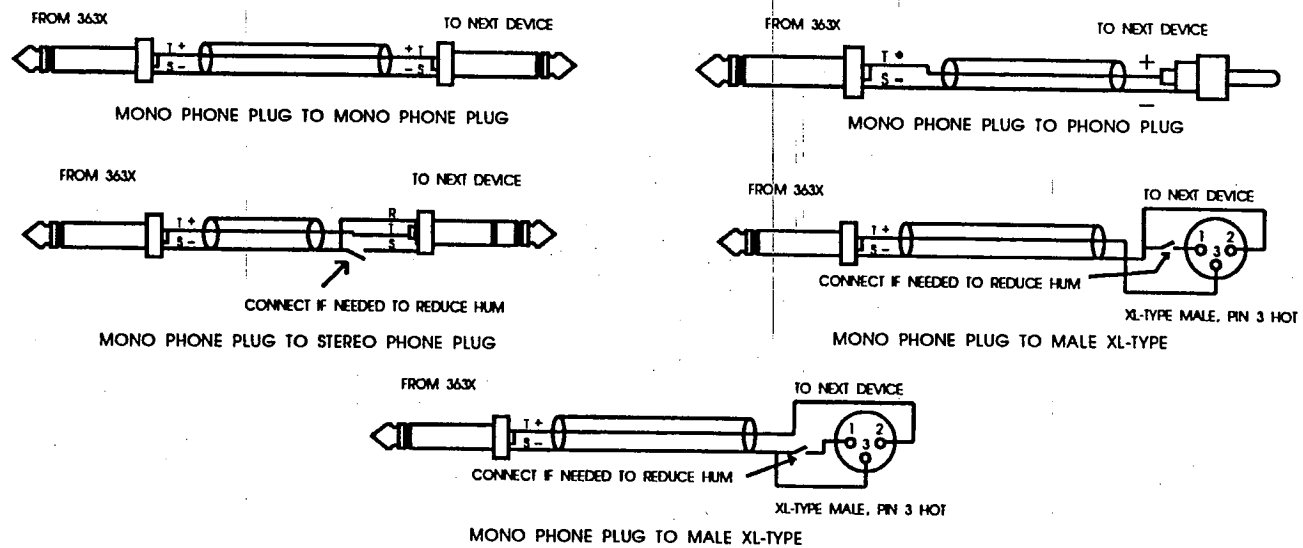

Figure 17: Output Connections

Connect Audio Outputs

Each channel of the model 363X has a single-ended output amplifier driving the 1/4" mono phone jack, capable of driving a 600 ohm load to +18dBu.

NOTE: Wherever mono phone plugs are shown, stereo phone plugs may be substituted. Just leave the RING disconnected.

Maintenance

Maintenance and Troubleshooting

The 363X is an all-solid-state product with components chosen for high performance and excellent reliability. Each 363X is tested, burned in and calibrated at the factory and should require no adjustment of any type throughout the life of the unit. We recommend that your 363X be returned to the factory should circumstances arise which necessitate repair or recalibration. The 363X requires no special preventive maintenance.

Technical Support

If you require technical support, contact dbx customer service. Be prepared to accurately describe the problem. Know the serial number of your 363X — this is printed on a sticker attached to the rear panel.

Telephone: (1) 415/351-3500
or Fax: (1) 415/351-0500
or Telex: 17-1480

or Write: Customer Service
dbx Professional Products
a division of AKG Acoustics Inc.
1525 Alvarado Street
San Leandro, CA 94577 USA

Factory Service

Always contact Customer Service before returning a product to the factory for service. Often, a problem is relatively simple and can be quickly fixed after telephone consultation.

Products can be returned to the factory for service *only* after Customer Service has issued a Return Authorization number. This number flags the returned unit for priority treatment when it arrives on our dock, and ties it to the appropriate information file.

Please refer to the terms of your Limited Two-Year Standard Warranty, which extends to the first end-user. After expiration of the warranty, a reasonable charge will be made for parts, labor, and packing if you choose to use the factory service facility. In all cases, you are responsible for transportation charges to the factory. dbx will pay return shipping if the unit is still under warranty.

Maintenance

dbx 363X

Shipping Instructions

Use the original packing material if it is available or a sturdy, double-walled carton no smaller than 22 x 12 x 5 inches (55.75 x 31 x 13 cm). Place the unit in a plastic bag to protect it from moisture and to protect the finish, then pack it in the carton with at least 1.5 inches (3.75 cm) of cushioning on all sides of the unit. Use enough packing to prevent the module from moving during shipment. Seal the carton with 3-inch (7.6 cm) reinforced fiberglass or polyester sealing tape.

Mark the package with the name of the shipper, and with these words in red:

DELICATE INSTRUMENT, FRAGILE!

Insure the package properly. Ship prepaid, not collect. Do not ship parcel post.

Specifications

Input Characteristics

Key Input:

Unbalanced = 20k Ω

Maximum Key Input Level:

+20dBu

Key Input Connector Type:

1/4" Phone Jack

Audio Input Impedance:

Unbalanced = 10k Ω

Maximum Audio Input Level:

+18dBu

Audio Input Connector Type:

1/4" Phone Jack

Output Characteristics

Output Source Impedance:

Unbalanced = 22 Ω , Phone

Minimum Load Impedance:

Greater than or equal to 600 Ω

Maximum Output Level:

+18dBu into 600 Ω

Connector Type:

1/4" Phone Jack

Performance Characteristics

Frequency Response:

20Hz-20kHz (\pm 0.5dB)

THD Distortion:

<0.08%, Any amount of compression @ 1kHz

IMD Distortion:

<0.2% SMPTE

Equivalent Input Noise:

-85dBu Unweighted

Dynamic Range:

103dB

Attack Time:

<100 μ s

Release Time:

30ms - 9sec

Threshold Range:

-90 to +20dBu

Threshold Characteristic:

Hard-Knee

Attenuation:

90dB

Hold Time:

Adjustable, 0 to 3Sec

Specifications

Controls, Indicators, Meters

Controls:

Stereo Couple Switch, 1 per channel;
Threshold Knob; Hold Knob; Key Monitor
Switch; Key Engage Switch; Bypass Switch

Indicators:

Stereo Couple: Red; Open: Green; Hold:
Yellow; Release: Red; Key Monitor: Red;
Key Engage: Red; Bypass: Red

Stereo Coupling:

Internal; Front Panel Switch

dbx 363X

General

Power Line Requirements:

90 - 120VAC, 50/60Hz, Switchable to 240VAC

Power Consumption:

7W

Dimensions:

1.75" (H) x 8.5" (W) x 7.25" (D)

Rack Space:

1 Rack Unit, Half Rack Design

Weight:

2.5lbs/5lbs shipping weight

Warranty:

Two-year, parts and labor: Subject to limitations set forth in our Standard Warranty. Factory assistance and service will be available throughout the life of the product.

Specifications are subject to change.

AKG Acoustics Inc.

dbx Model 363X Test Procedure
Revision 03 - 10/9/90

Note: The following steps need not necessarily be performed in the exact order or manner described. However, AKG Engineering must be consulted before making any such changes.

A. Power supply

1. Plug the transformer into an outlet with 120 VAC.
2. Monitor TP2 and verify +24 volts DC +/- 3 volts with less than 0.5 volts peak-to-peak ripple.
3. Monitor TP3 and verify -24 volts DC +/- 3 volts with less than 0.5 volts peak-to-peak ripple.
4. Monitor TP4 and verify +12 volts DC +/- 0.6 volts.
5. Monitor TP5 and verify -12 volts DC +/- 0.6 volts.

B. RMS Symmetry

1. Set all front panel switches to the OUT position.
2. Connect a 50 Hz sine wave at 1 volt rms to Channel 1 input (rear panel).
3. Monitor TP16 and adjust R19 for a symmetrical 100 Hz sine wave approximately 350 mV peak-to-peak. This is the same as adjusting for minimum content at 50 Hz.
4. Repeat for Channel 2 using TP17 and R76.

C. VCA Symmetry

1. Set all front panel switches to the OUT position.
2. Connect a tone-burst oscillator to the Channel 1 KEY INPUT and press the Channel 1 KEY ENGAGE button. The frequency of the tone should be about 1 kHz. The ON level should be approximately 1 volt rms and the OFF level should be less than 100 mV. The repetition rate should be 4 per second or high enough to produce easily viewed traces on an oscilloscope. Any combination of levels and repetition rate that opens and closes the gate will work.
3. Set the Channel 1 HOLD and RELEASE controls to the full counter-clockwise position (HOLD to "OFF" and RELEASE to "3k").
4. Adjust the Channel 1 THRESHOLD knob until the green OPEN LED, yellow HOLD LED and red RELEASE LED are flashing on and off.
5. Monitor the Channel 1 output and adjust R5 for minimum AC waveform.
6. Repeat for Channel 2 using R62.

D. VCA gain

1. Set all front panel switches to the OUT position.
2. Apply a 1 kHz sine wave at 1 volt rms +/- to the Channel 1 input.
3. Adjust the Channel 1 THRESHOLD knob so that the green OPEN LED

is on.

4. Monitor the Channel 1 output and adjust R18 for unity gain ± 0.3 dB at the Channel 1 output (1 volt rms ± 35 mV).
5. Repeat for Channel 2 using R75.

E. HOLD current

1. Set the Channel 1 HOLD control to the full counter-clockwise position ("OFF").
2. Measure the DC voltage between TP8 and TP9.
3. Adjust R47 for 365 mV DC ± 5 mV.
4. Repeat for Channel 2 using TP12, TP13, and R104.

F. RELEASE current

1. Set the Channel 1 RELEASE control to the full counter-clockwise position ("3k").
2. Measure the DC voltage between TP10 and TP11.
3. Adjust R53 for 33 mV DC ± 1 mV.
4. Repeat for Channel 2 using TP14, TP15, and R110.

G. General operation

1. Set all of the front panel switches to the OUT position.
2. Connect a 1 kHz sine wave at 1 volt rms to the Channel 1 input.
3. Center the front panel THRESHOLD knobs.
4. Turn the front panel HOLD and RELEASE knobs fully clockwise.
5. Verify that the Channel 1 green OPEN LED is on, the Channel 2 red RELEASE LED is on, and all others are off.
6. Turn the THRESHOLD knob fully clockwise and verify that the green OPEN LED turns off, the yellow HOLD LED turns on for 3 seconds ± 0.5 seconds, and then the red RELEASE LED slowly turns on - it should take 2 to 3 seconds to reach full brightness.
7. Monitor the Channel 1 output and verify that there is no signal there.
8. Press the CHANNEL 1 BYPASS button and verify that the signal appears at the Channel 1 output. Return the CHANNEL 1 BYPASS button to the OUT position. Recenter the Channel 1 THRESHOLD knob.
7. Disconnect the input and instead connect a 1 kHz sine wave at 1 volt rms to the Channel 1 KEY input.
8. Verify that both red RELEASE LED's are on.
9. Monitor the Channel 1 output and verify that there is no signal there.

10. Press the Channel 1 KEY MONITOR button and verify that the signal is there (1kHz sine wave at 1 volt rms). Return the Channel 1 KEY MONITOR button to the OUT position.
11. Press the Channel 1 KEY ENGAGE button and verify that the Channel 1 green OPEN LED turns on and the red Channel 1 RELEASE LED turns off.
12. Repeat for Channel 2.
13. Set all front panel switches to the OUT position.
14. Center all front panel knobs.
15. Connect a 1 kHz sine wave at 1 volt rms to the Channel 1 input.
16. Verify that the Channel 1 green OPEN LED is on, the Channel 2 red RELEASE LED is on, and all other LED's are off.
17. Press the STEREO COUPLE button and verify that the Channel 2 red RELEASE LED turns off and the Channel 2 green OPEN LED turns on.
18. Press each of the front panel buttons and verify that the associated red LED turns on when the button is IN and is off when the button is OUT.

H. THRESHOLD calibration

1. Connect a 1 kHz sine wave at -25 dBv +/- 0.1 dB (76.6 - 78.4 mV rms) to the Channel 1 input.
2. Turn the Channel 1 THRESHOLD knob fully counter-clockwise, then turn it clockwise until the green OPEN LED just turns off.
3. Verify that the white line is vertical +/- 5 degrees.
4. Turn the THRESHOLD knob fully counter-clockwise ("-60").
5. Change the oscillator level to off (< 100 micro volts).
6. Increase the oscillator level until the green OPEN LED just turns on.
7. Verify that the oscillator level is 0.775 mV rms +/- 3 dB (0.55 - 1.10 mV rms).
8. Turn the THRESHOLD knob fully clockwise ("+20").
9. Increase the oscillator level until the green OPEN LED just turns on.
10. Verify that the oscillator level is 7.75 volts rms +/- 3 dB (5.5 - 11.0 volts rms).
11. Repeat for Channel 2.

I. Noise

1. Set all front panel switches to the OUT position.
2. Connect a shorting plug to the Channel 1 input with an impedance of 600 ohms or less.
3. Push the STEREO COUPLE button and the Channel 1 KEY ENGAGE button.

4. Connect a 1 kHz sine wave at 1 volt rms to the Channel 1 KEY INPUT (rear panel).
5. Center the front panel knobs.
6. Verify that both green OPEN LED's are on.
7. Measure the AC noise at the Channel 1 and 2 outputs, band-limited to 20 kHz.
8. Verify that the noise is less than -85 dBv (44 micro volts rms).

J. Frequency response

1. Set all front panel switches to the OUT position.
2. Connect a 1 kHz sine wave at 1 volt rms to the Channel 1 input.
3. Set the THRESHOLD control to the center position.
4. Verify that the green OPEN LED is on.
5. Measure the Channel 1 output level and verify that it is 1 volt rms +/- 0.3 dB (see step D.).
6. Measure the output level at 20 Hz, 200 Hz, 5 kHz, and 20 kHz.
7. Verify that the output level for all of the above frequencies is the same as that measured in step 5 +/- .5 dB.
8. Repeat for Channel 2.

K. Distortion

1. Set all front panel switches to the OUT position.
2. Connect a 1 kHz sine wave at 1 volt rms to the Channel 1 input.
3. Connect a 590 ohm, 1 % resistor from the Channel 1 output to ground.
4. Set the THRESHOLD control to the center position.
5. Verify that the green OPEN LED is on.
6. Measure the Total Harmonic Distortion at the Channel 1 output and verify that it is less than .08 % .
7. Repeat for Channel 2.